

INSTALLATION OF DRIVER RESTRAINT SYSTEMS

CROTCH STRAP SHOULD BE ANCHORED IN LINE WITH THE CHEST

THE SEAT BELT ANCHOR SHOULD BE 2½ INCHES FORWARD OF THE BACK LINE OF THE DRIVER



5 POINT SYSTEM

SEAT BELTS SHOULD BE ANCHORED APART THE SAME DISTANCE AS THE DRIVER IS WIDE. MOUNTING BRACKETS SHOULD BE ANGLED THE SAME DIRECTION AS BELT PULL AND NOT TILTED IN OR OUT

(2)

ROLL BAR MOUNTED SHOULDER HARNESS

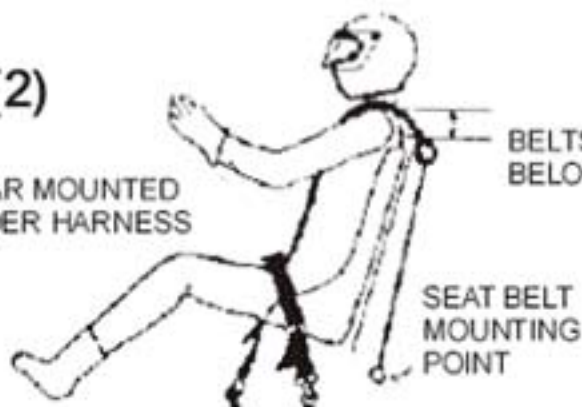

BELTS ANCHORED 4" BELOW SHOULDER LINE.

SHOULDER HARNESS SHOULD BE ANCHORED AT A 45 DEGREE ANGLE FROM THE SEAT. IF MOUNTED TO A ROLL BAR CROSS BRACE LOCATED 4 INCHES BELOW THE SHOULDER LINE.

(2A)



6 POINT SYSTEM

CROTCH STRAP MOUNTS AS FAR APART AS COMFORTABLE

WINDOW NET RECOMMENDED
INSTALLATION

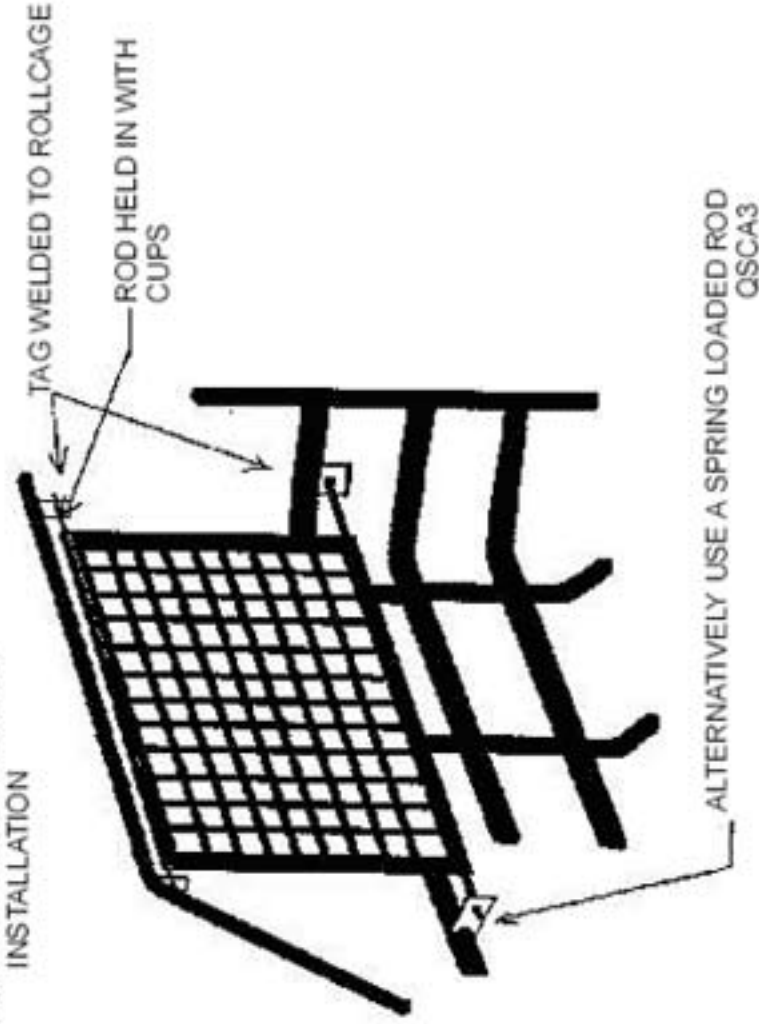

WINDOW NET RECOMMENDED
INSTALLATION

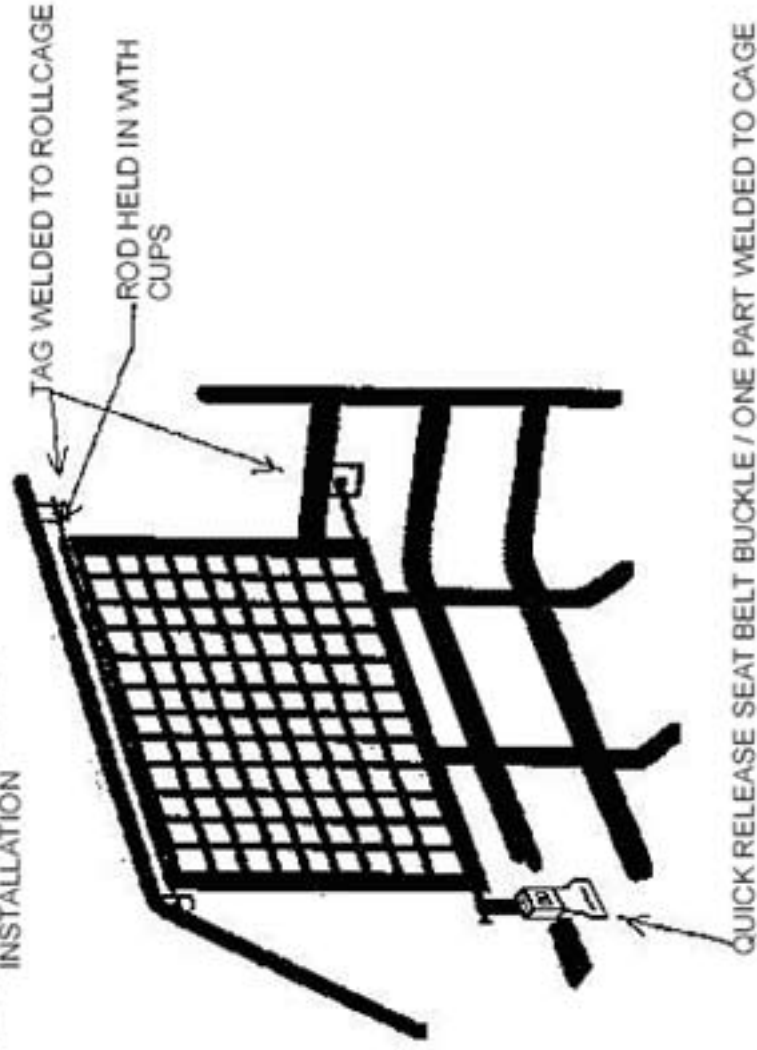

Roll cage & bumpers

Roof plate not shown for clarity

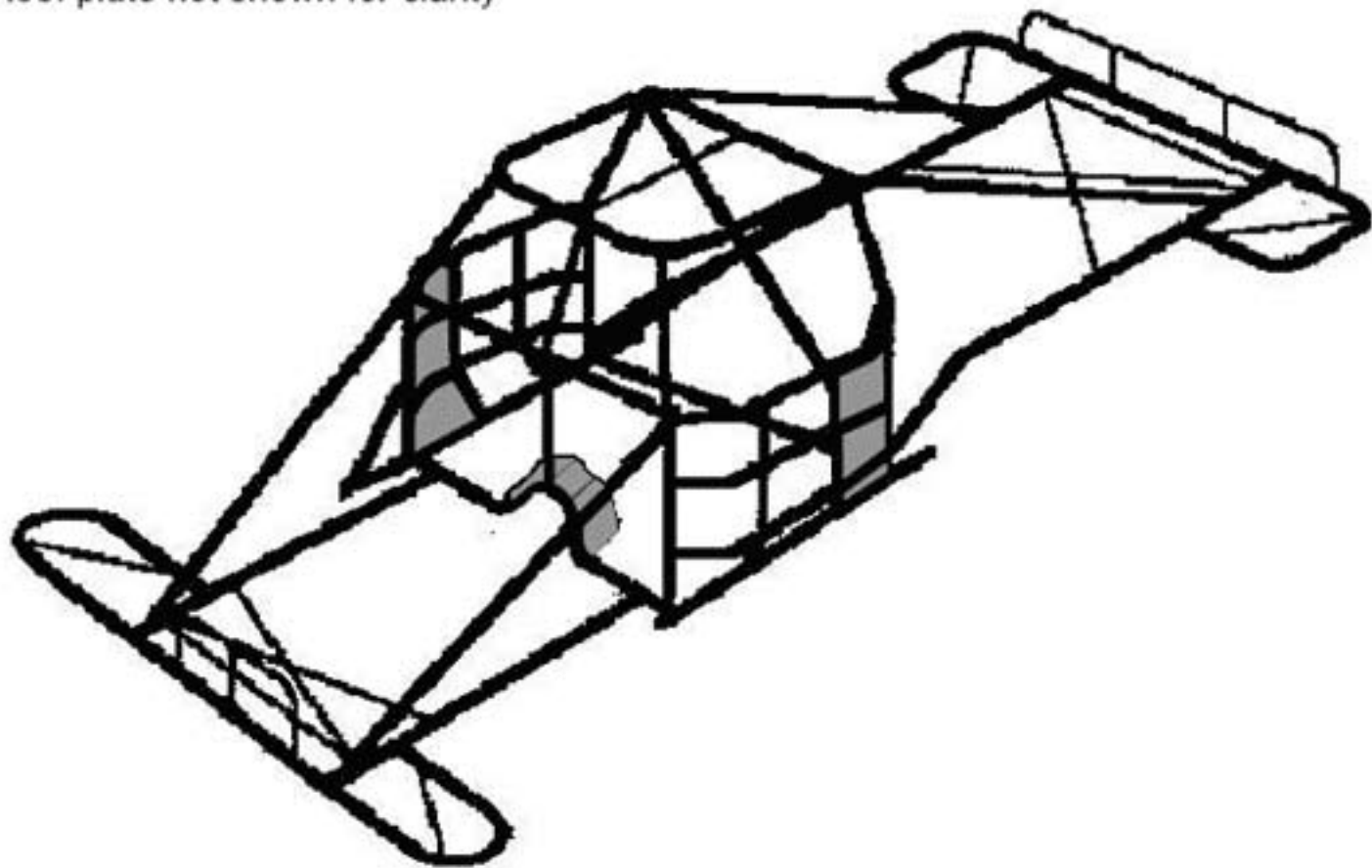

Plan view of roll cage and bumpers

Front brace bars

Option -A- Two bars extending from bottom windscreen bar height at the front roll cage legs to the chassis rails.

Option -B- Two bars extending from bottom windscreen bar at the centre to the chassis rails.

Both options allow for the brace bars to be within the body line at the front.

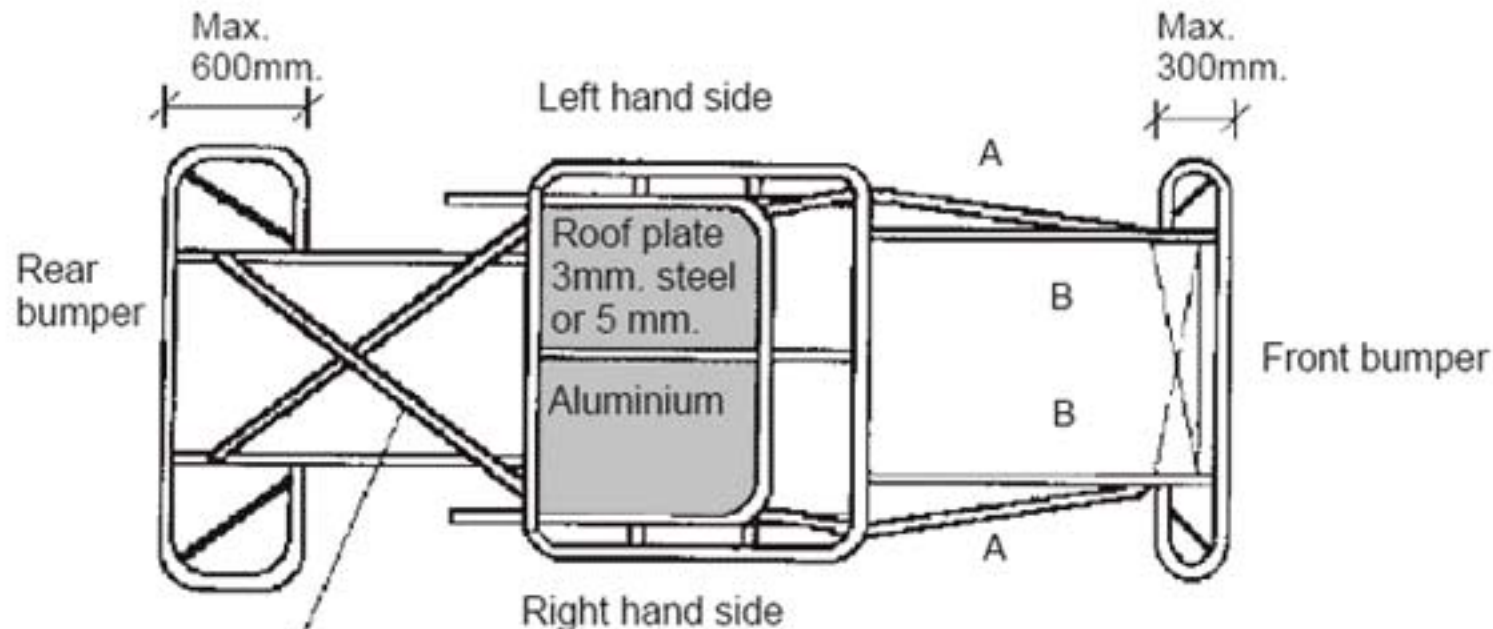

Rear brace bars may be crossed over as shown or can be mounted independently either side

SIDE VIEW - DRIVERS SIDE

*A = 38 OD. X 3.25 ERW TUBE
or 32 N.B.M. Black pipe (42 od. x 3.25 w.t.)*

B = 40 X 40 X 3.0 S.H.S.

C = 50 X 50 X 5.0 ANGLE.

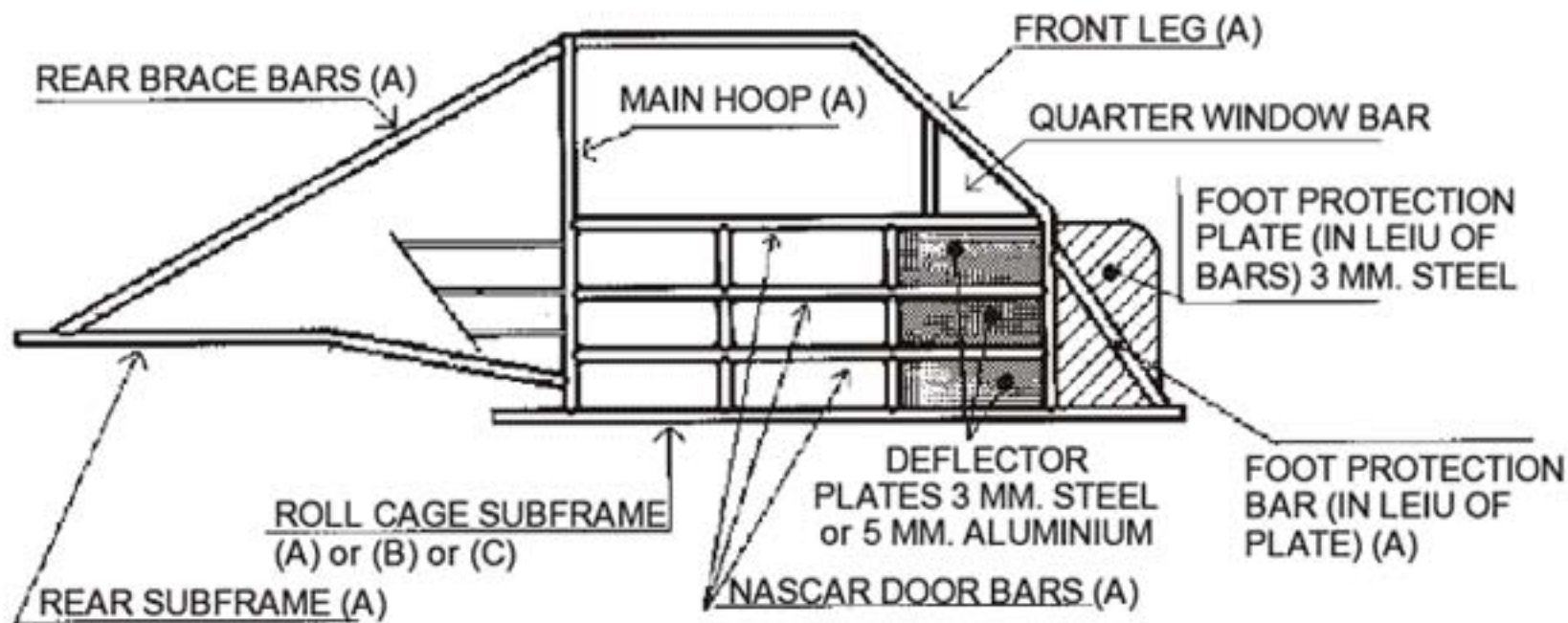

SIDE VIEW - PASSENGER SIDE

*A = 38 OD. X 3.25 ERW TUBE
or 32 N.B.M. Black pipe (42 od. x 3.25 w.t.)*

B = 40 X 40 X 3.0 S.H.S.

C = 50 X 50 X 5.0 ANGLE.

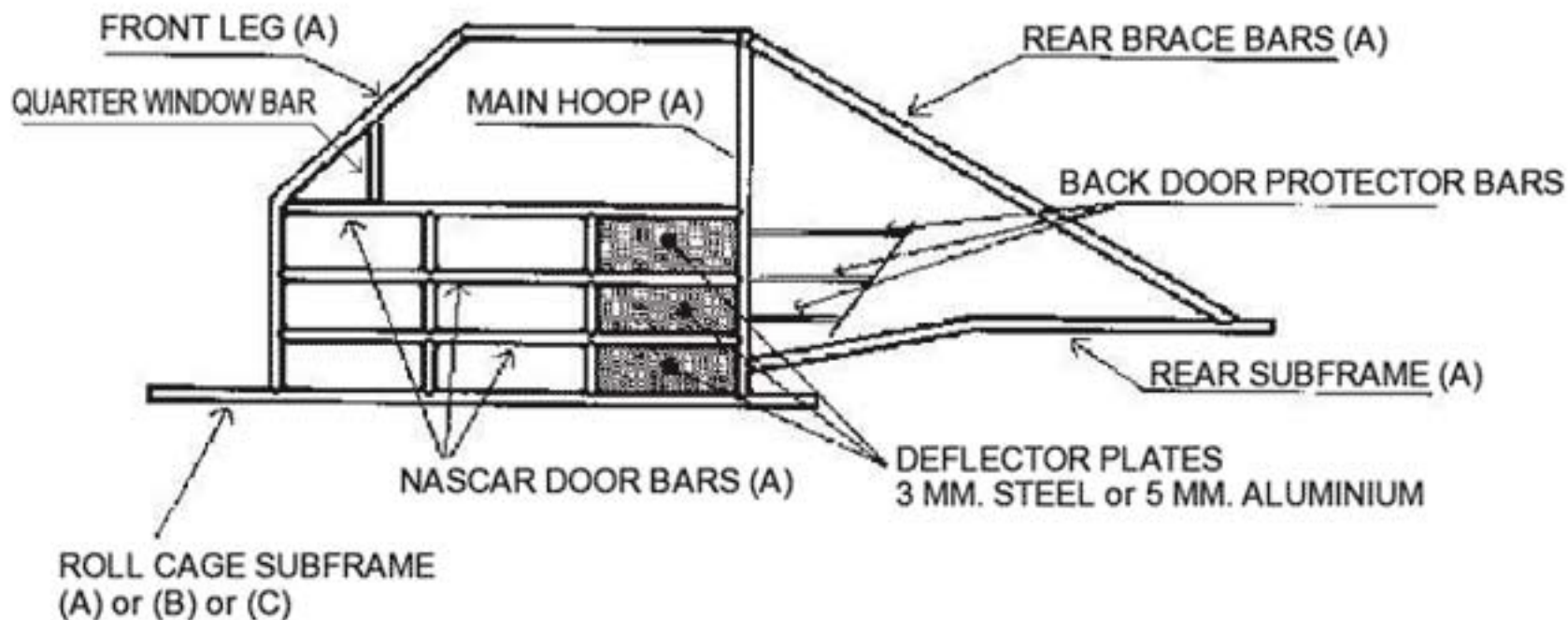

SIDE VIEW - DRIVER'S SIDE

**A = 38 OD. X 3.25 ERW TUBE
or 32 N.B.M. Black pipe (42 od. x 3.25 w.t.)**

B = 40 X 40 X 3.0 S.H.S.

C = 50 X 50 X 5.0 ANGLE.

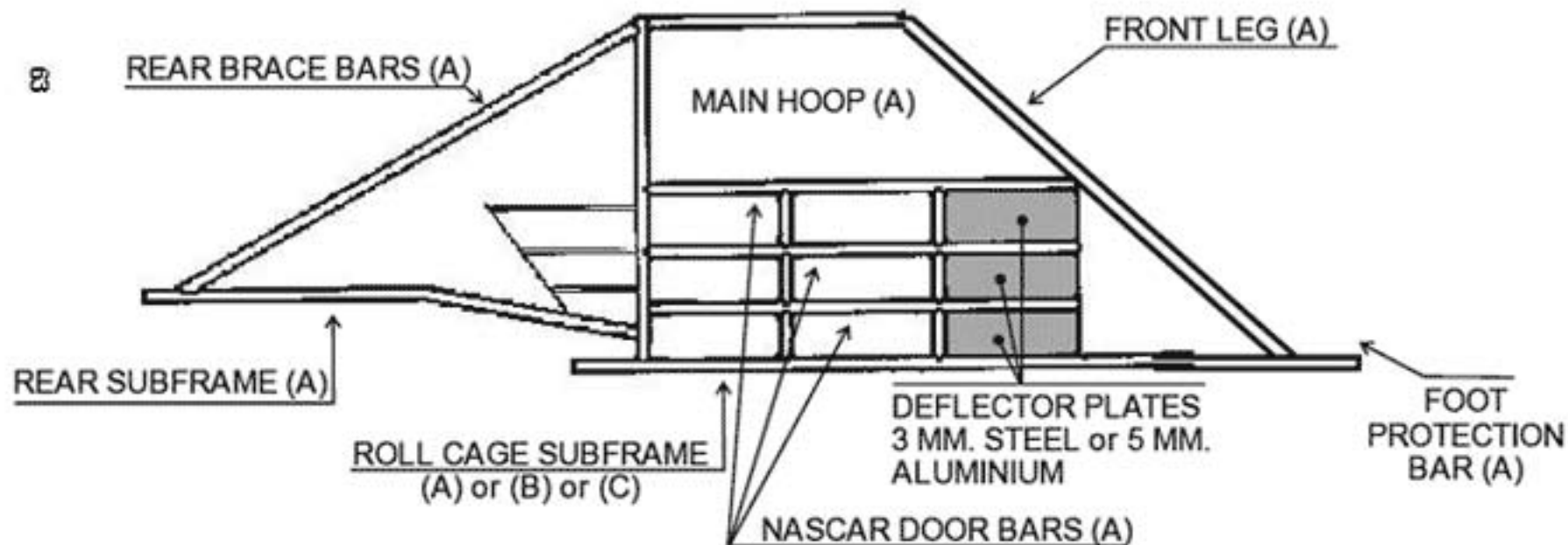

SIDE VIEW - PASSENGER SIDE

*A = 38 OD. X 3.25 ERW TUBE
or 32 N.B.M. Black pipe (42 od. x 3.25 w.t.)*

B = 40 X 40 X 3.0 S.H.S.

C = 50 X 50 X 5.0 ANGLE.

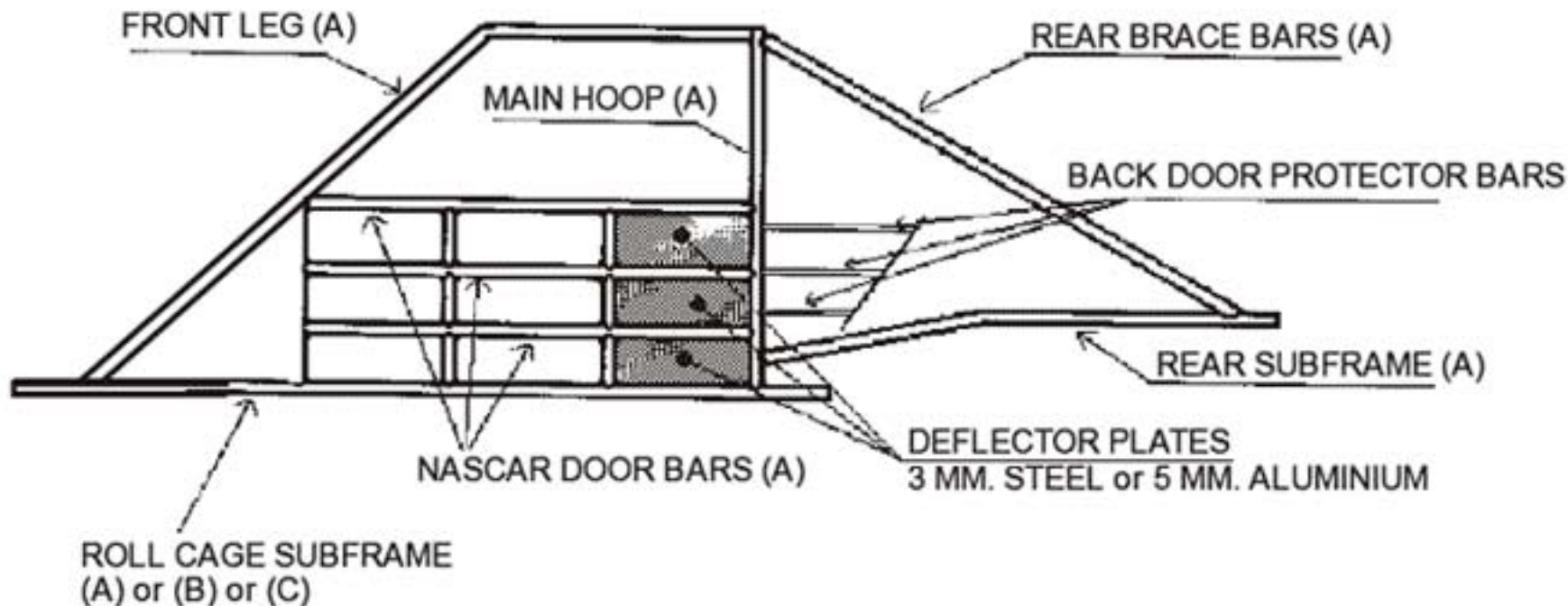

FRONT ELEVATION

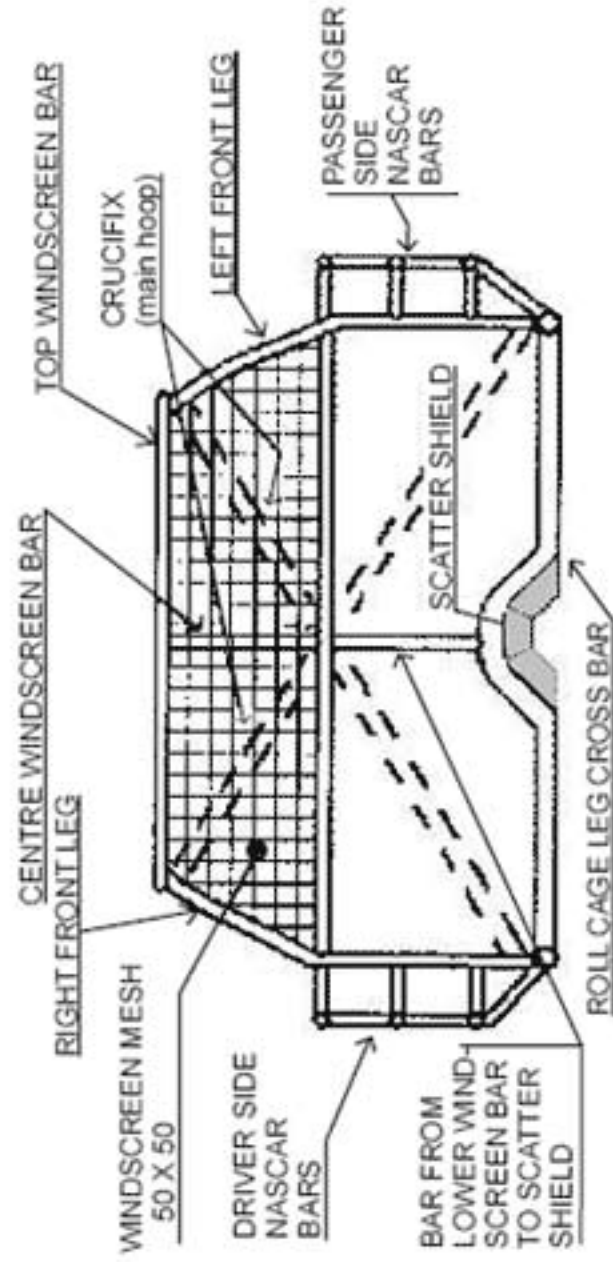

REAR ELEVATION

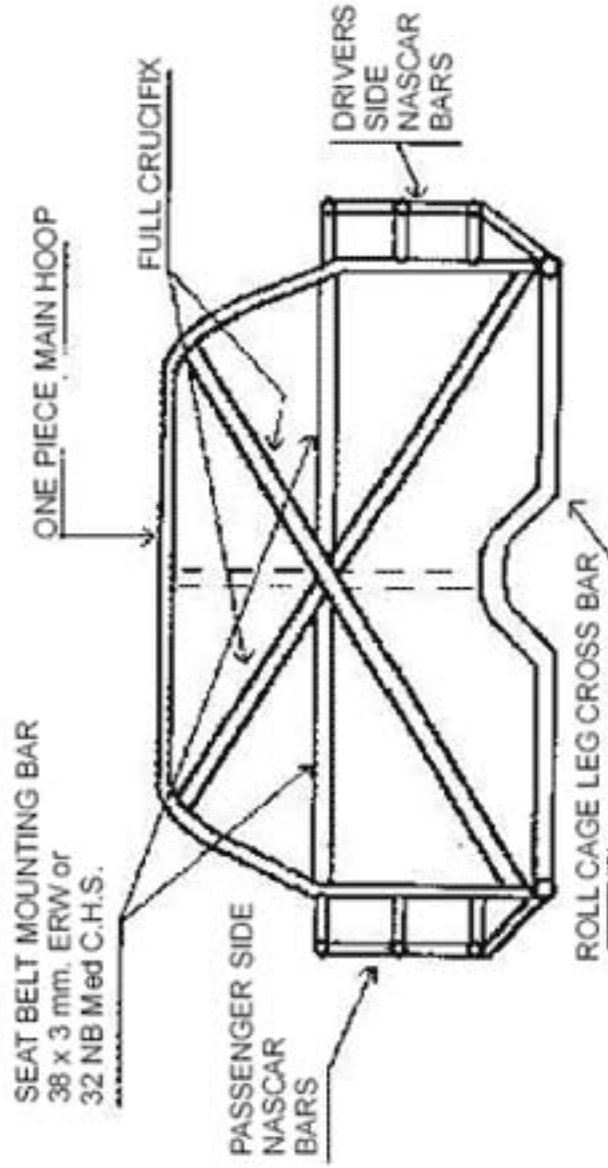

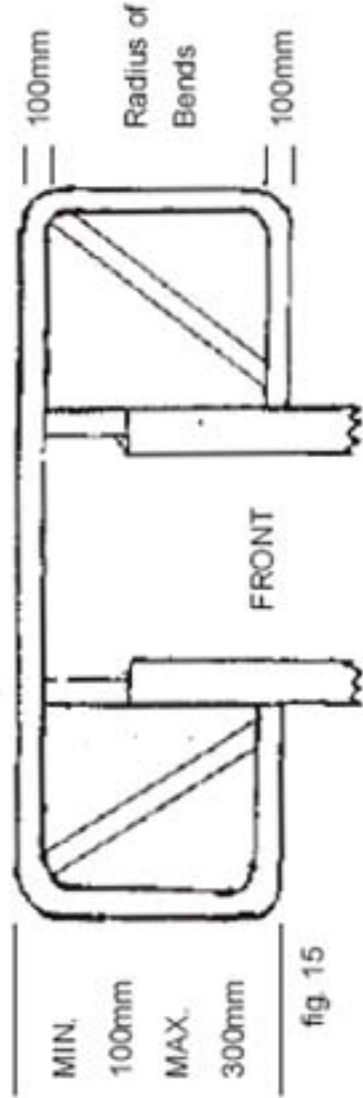
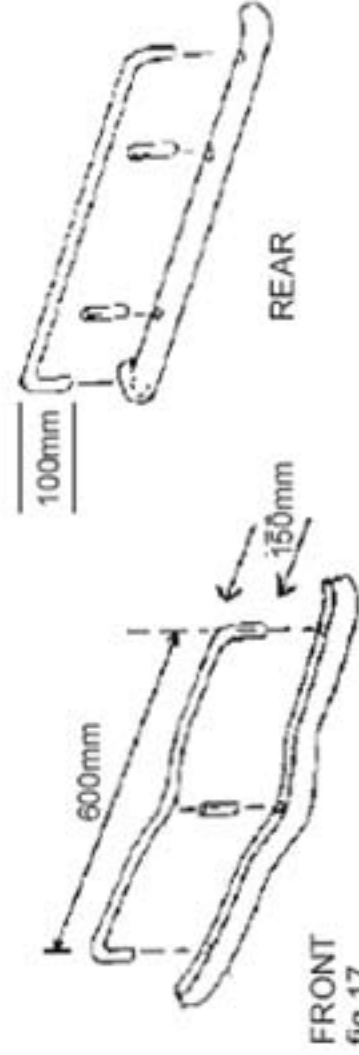
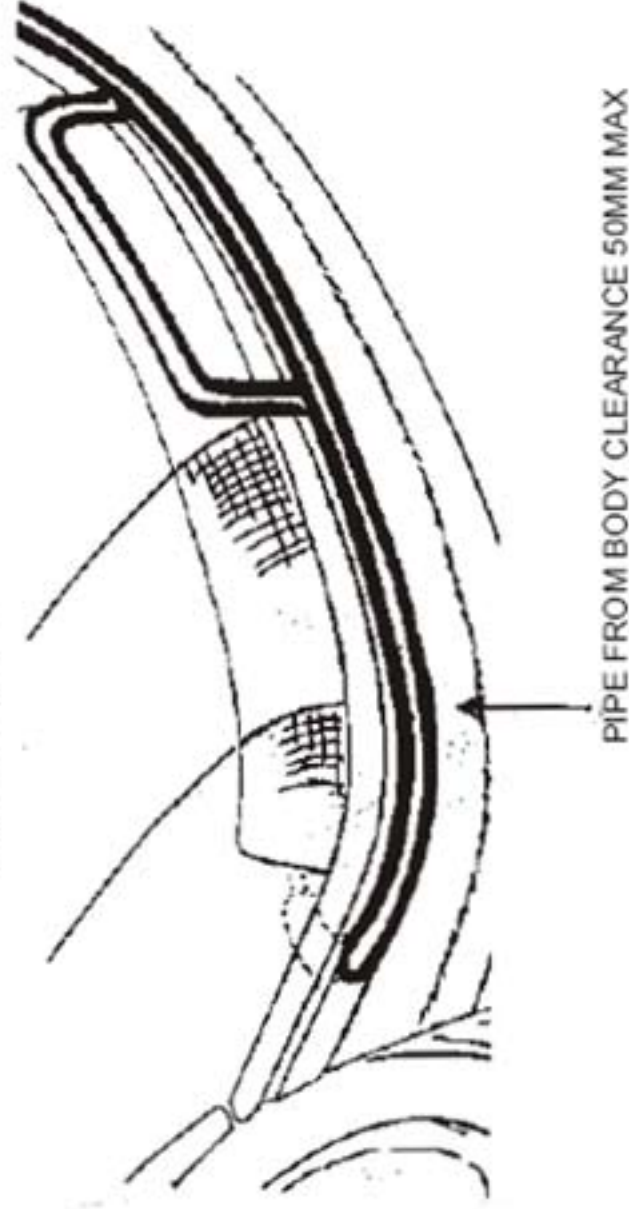
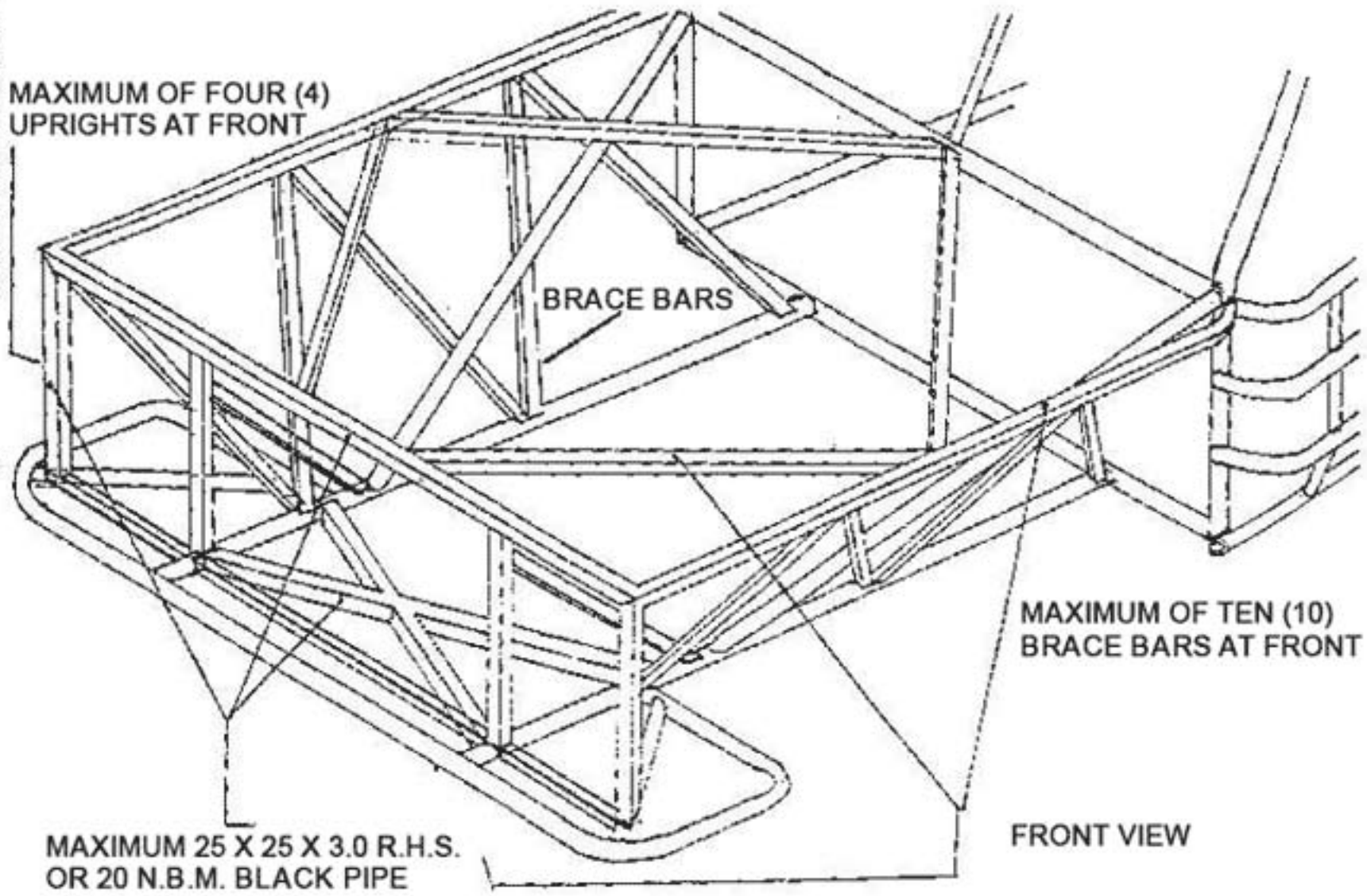

fig. 15



Override protection





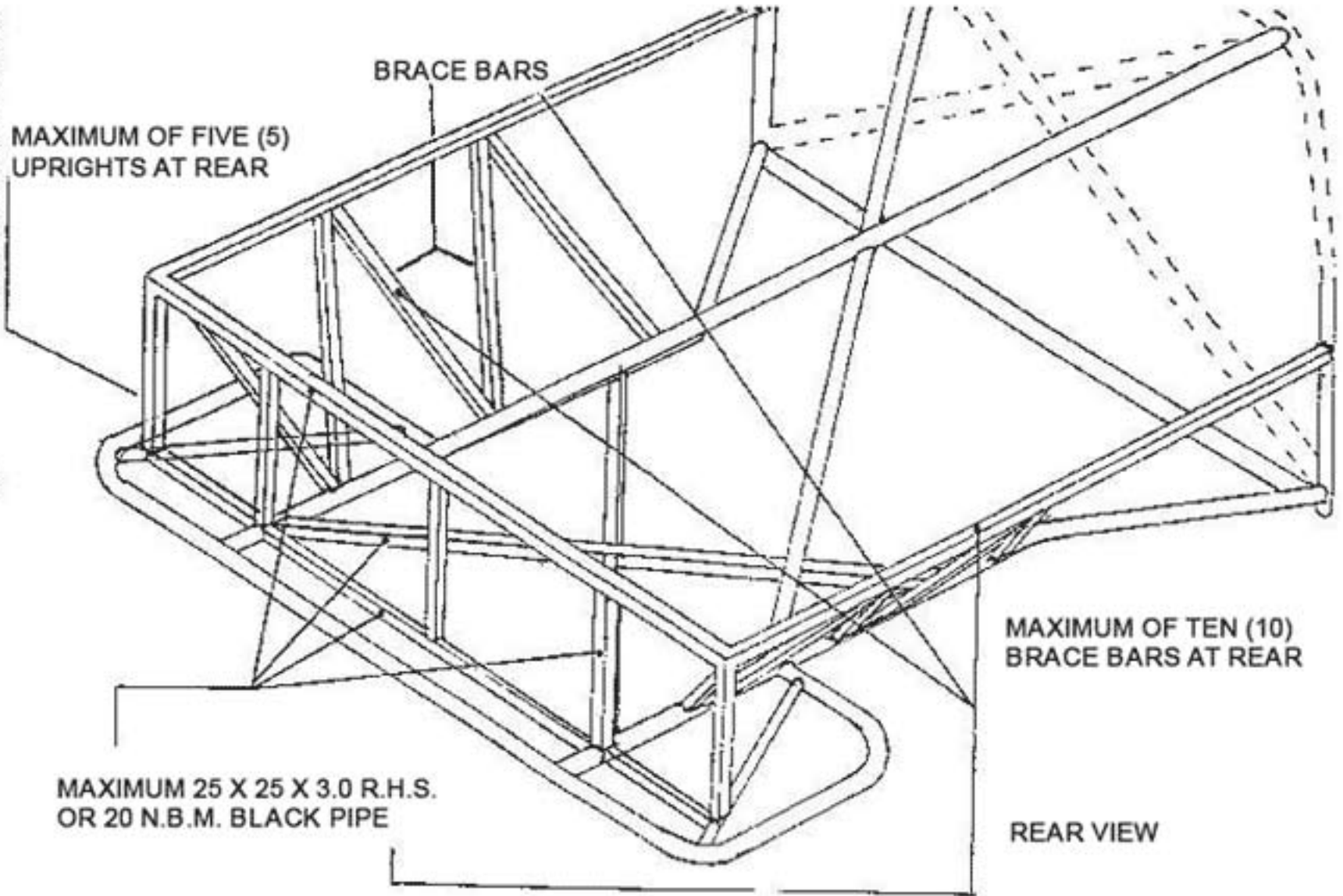

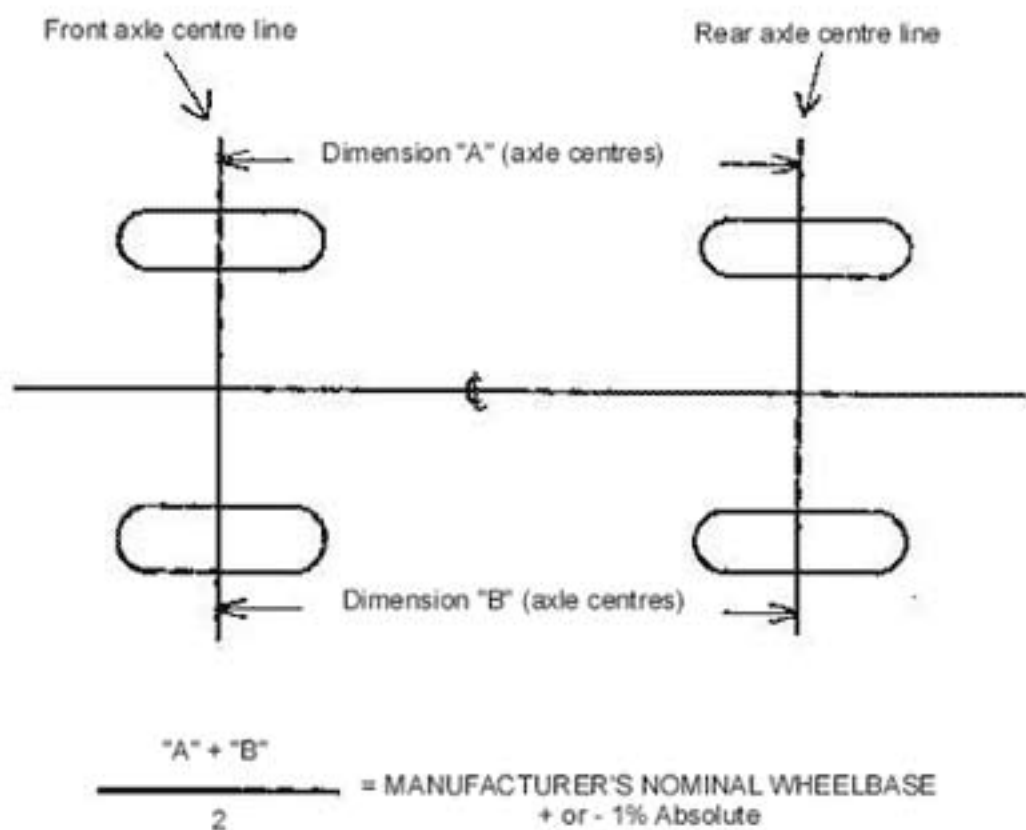
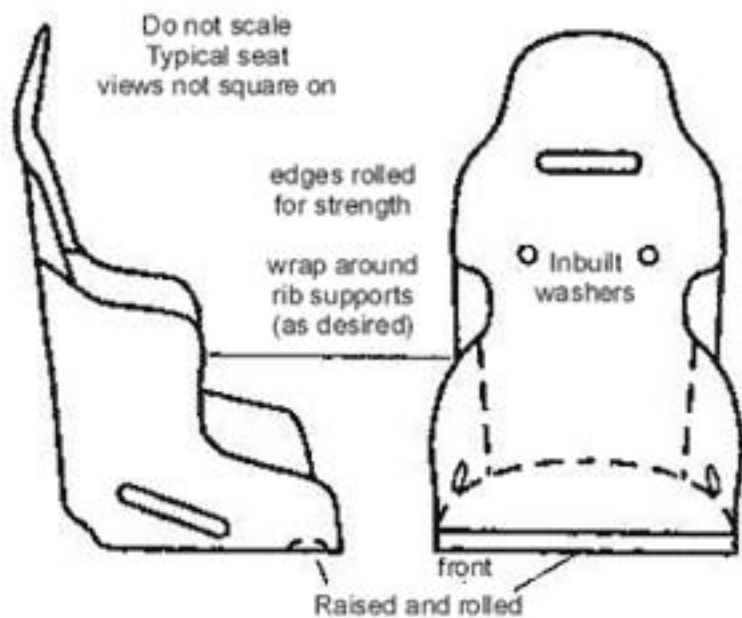

STREET SEDAN TYRE & RIM

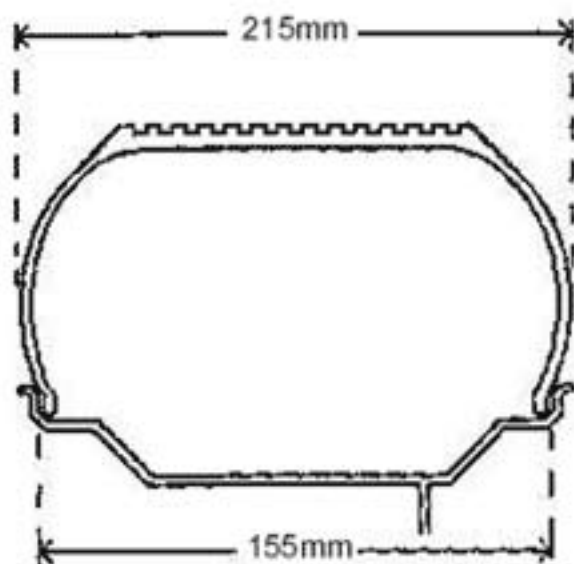

Manufacturers track + 50mm

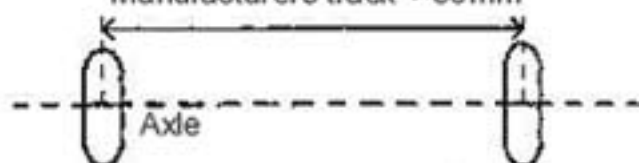

SUPER STREET SEDAN TYRE & RIM

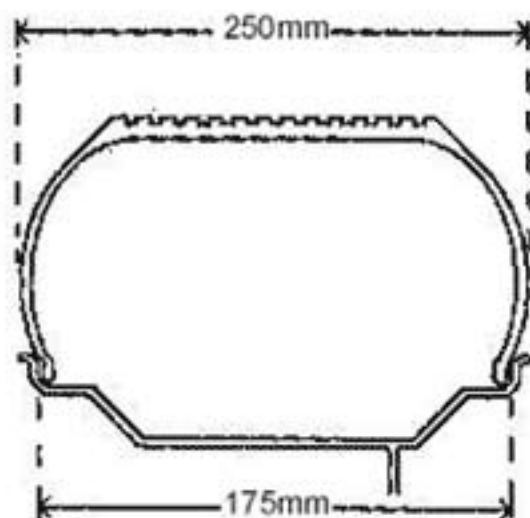

Manufacturers track = 75mm

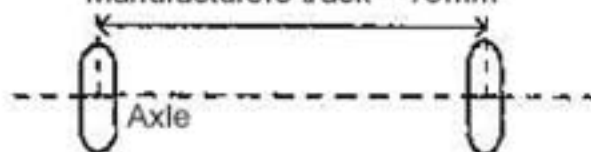

REAR SPOILER - SUPER STREET SEDAN

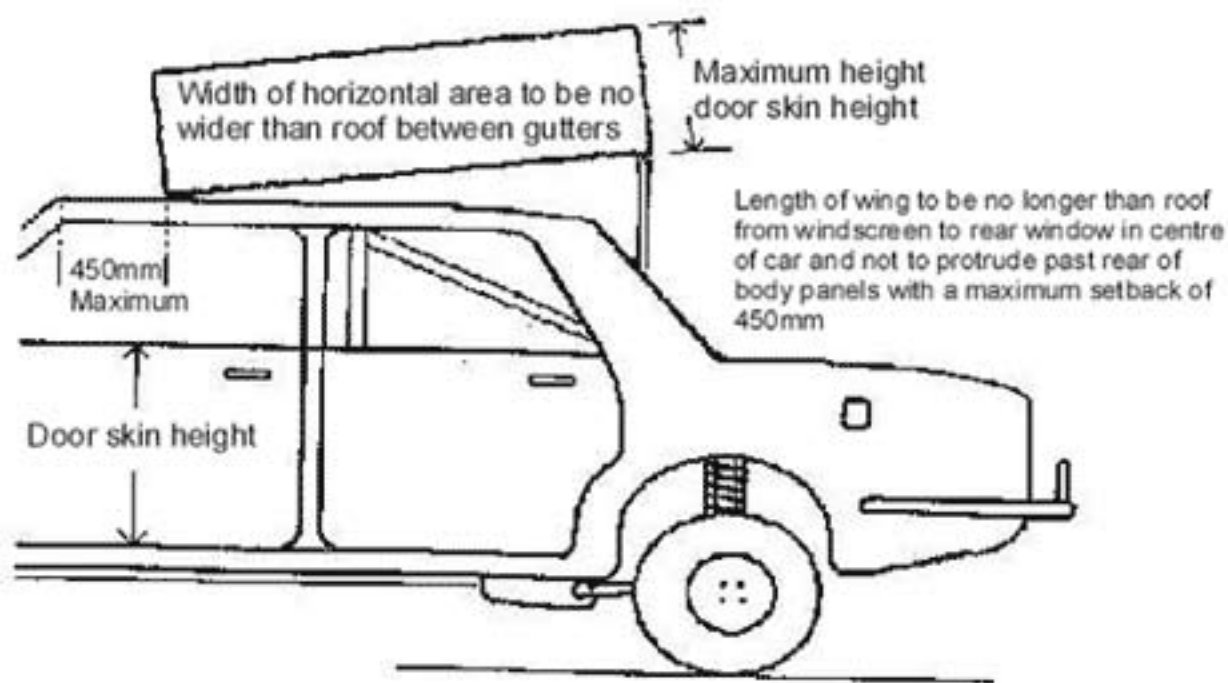
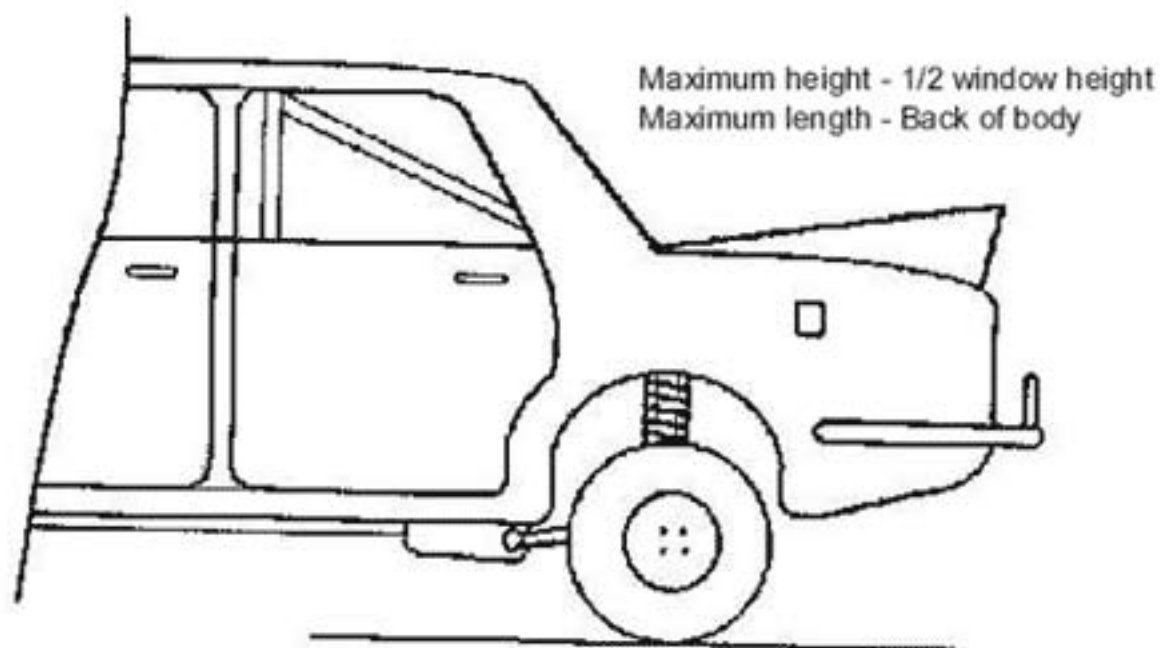

SUPER STREET SEDAN WING OPTION - instead of spoiler